

## Galvanized Louvered Fence GJ/40 (in the box / disassembled)

### STANDARD 6'x6' Louvered Fence Panel KIT

Louvered Slats BOX – 40pc.

Frame BOX – 8 sets

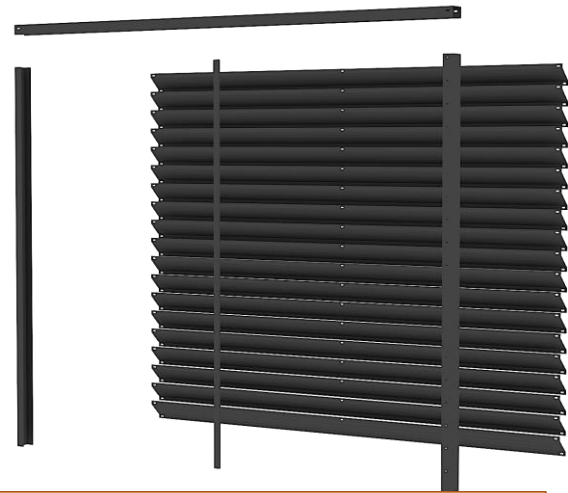

Custom Fence Panels Max Length is 2440 mm / (8 ft)

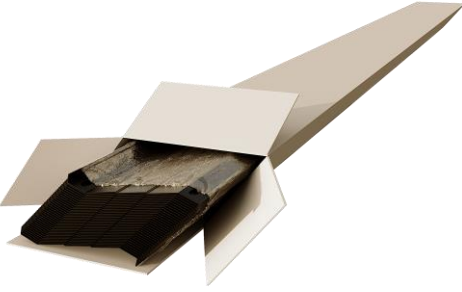

### Louvered Panel SLATS

Slats thickness - 0.7 mm  
 LS 110x1816mm - **\$9.00ea.**  
 (4.33''x 5'11.5'')

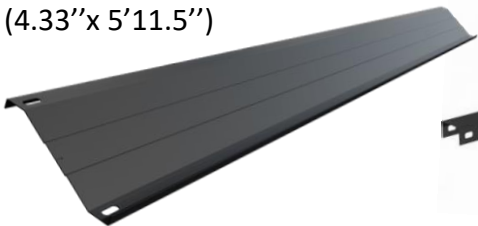

### Louvered FRAME kit

Profile thickness - 1.2 mm  
 1814x1830/90mm - **\$55.00ea.**  
 (5.95'x6'/0.3')

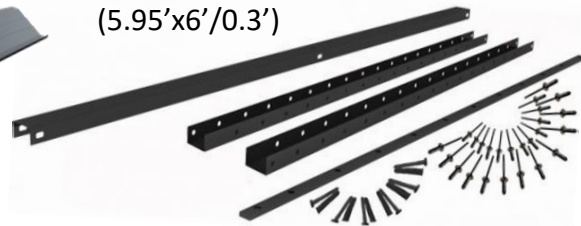

### Louvered Fence KIT

electrostatic Powder Coating  
 cured at 392°F



### **STANDARD Louvered Panel Kits (disassembled)**

Panel Size	RAL/STOCK	SLATS	GJ FRAME	Rivets	Weight	Pace	PRICE /KIT
<b>GJ 1814x1830/90</b> (5.95'x6'/0.3')	9005	20 pc.	1 kit	115 pc.	26 kg/57 lbs.	90 mm (0.3')	<b>\$235.00</b>

### **CUSTOM**

#### Louvered Panel Kits (in the box/disassembled)

GJ KIT= GJ Frame + GJ Slats

GJ Frame Kit = Profile Left + Profile Right + Reinforcement profile + Rivets

Pace	Price /sq ft
<b>90 mm (0.3')</b>	<b>\$7.00</b>
110 mm (0.36')	\$6.50
130 mm (0.43')	\$6.00

**Custom Size Louvered Fence Panel Kit: Starting at \$150.00 per panel.**

### **Powder Coated Textured Colors (RAL)**

- 90031**  
 WHITE
- 70301**  
 STONE GREY
- 70121**  
 BASALT GREY
- 70161**  
 ANTHRACITE GREY
- 90051**  
 BLACK
- 80191**  
 GREY BROWN
- 80171**  
 CHOCOLATE BROWN



**All prices are subject to change without prior notice !!!**

## Louvered Gates GJ/40/HDG/ (Hot Dip Galvanized)



**Driveway Swing Gate /HDG/GJ**  
 1760x4270/90mm - 5.8'x14'/0.3'  
**\$1,845.00 /pc.**

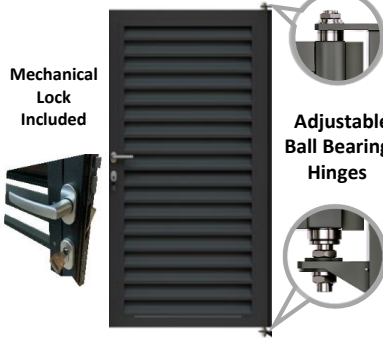

**Pathway Gate /HDG/GJ**  
 1760x1220/90mm  
 (5.8'x 4' / 0.3') **\$800.00 /pc.**

**For Gate 13,1-16ftW**

**STANDARD SWING GATE POSTS**

Post/HDG/ For Gates	Post/HDG/ Additional	Post/HDG/ For Gates	Post/HDG/ Additional	Post/HDG/ For Gates	Post/HDG/ Additional
<b>\$305.00 /pc</b>	<b>\$260.00 /pc</b>	<b>\$209.00 /pc</b>	<b>\$180.00 /pc</b>	<b>\$85.00 /pc</b>	<b>\$70.00 /pc</b>
<b>\$362.00 /pc. (4mm) (16,1-18ft)</b>					

**Electromechanical Lock CISA**



**\$250.00 /pc.**

**Mechanical Lock CISA**



**\$150.00 /pc**

**Standard Cantilever and Sliding Gate POSTS**

Post/HDG/ Support	Post/HDG/ STOP Cantilever	Post/HDG/ STOP Sliding
<b>\$190.00 /pc.</b>	<b>\$190.00 /pc.</b>	<b>\$190.00 /pc.</b>



**Sliding Gate /HDG/ GJ 1760x4600/90**  
 (5.8'x 15' / 0.3') **\$2,080.00/pc.**

**Comunello Hardware +25% !!!**

**HARDWARE INCLUDED !!!**

**Hot Dip Galvanized Cantilever Gates**

**Cantilever Hardware**

400kg & 800kg +350 mm  
 Comunello +500 mm

**STOP/SUPPORT Frame for Concrete Column/Wall**  
 HDG - **\$30.00ea.**

**Custom Louvered Gates (price per sq ft) !!!**

**Incorporated Pathway Gates, add + 20% to the calculated price of the Gate**

Louvered Fence	Driveway Swing Gate		Pathway Gate		Bi-Folding Gate	Sliding Gate HDG	Cantilever Gate HDG
	Hardware included		Lock NOT included !!!		Hardware NOT included !!!	Hardware included	Hardware included
	BB/HDG	For Gate BB-xl/HDG 14,1 - 18ft !!!	BB/HDG	BB-xl/HDG	HDG	HDG	HDG (Comunello Hardware +25%)
90 mm (0.3')	22.5	23.5	28.0	29.0	30.0	24.0	35.0
110 mm (0.36')	22.0	23.0	27.5	28.5	29.5	23.5	34.5
130 mm (0.43')	21.5	22.5	27.0	28.0	29.0	23.0	34.0

## Galvanized Horizontal Slat Fence GP-O (in the box / disassembled)

### STANDARD Horizontal Slat Panel

Slats BOX – 8 pc.

Frame BOX – 9 sets.

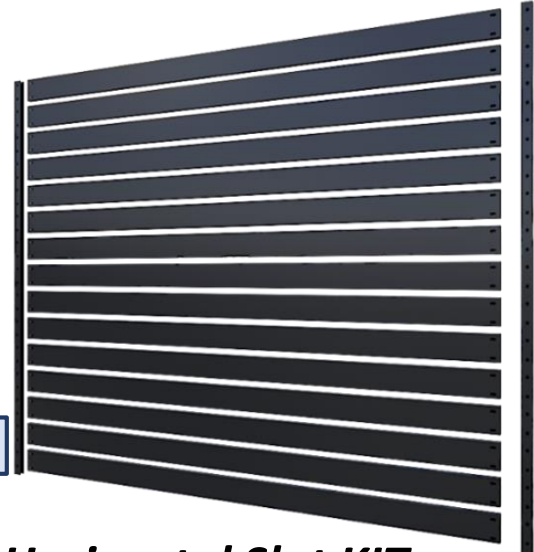

Custom Fence Panels Max Length is 2440 mm / (8 ft)

### Slat Fence Slats

Slats thickness - 0.9 mm  
 80mm x 1816mm - **\$17.00ea.**  
 (3.14' x 5'11.5'')

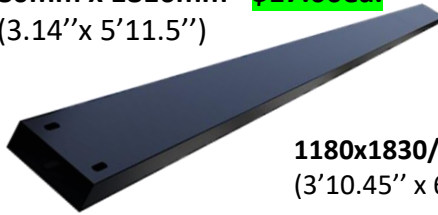

1180x1830/20mm - **\$28.00**  
 (3'10.45' x 6'/0.79'')

### Horizontal FRAME kit

Profile thickness - 1.0 mm  
 1780x1830/20mm - **\$39.00**  
 (5'10.08' x 6'/0.79'')

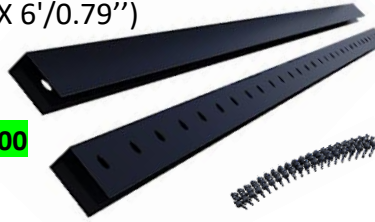

### Horizontal Slat KIT

electrostatic Powder Coating  
 cured at 392°F



### Standard Horizontal Slat Panel Kit /80 (disassembled)

Panel Size	RAL / STOCK	Slats	Frame	Rivets	Pace	Weight	Price/Kit
GP-O 1780x1830/20 (5'10.08" X 6'/0.79'')	9005	18 pc.	1 kit	85 pc.	20 mm (0.79'')	99 lbs / 45 kg	<b>\$345.00</b>
GP-O 1180x1830/20 (3'10.45" X 6'/0.79'')	9005	12 pc.	1 kit	60 pc.	20 mm (0.79'')	66 lbs / 30 kg	<b>\$230.00</b>

**Custom Size Horizontal Slat Fence Panel Kit: Starting at \$190.00 per panel**

### Custom Horizontal Slat Panel Kit /80 (disassembled)

GP-O KIT = GP-O Frame Kit + GP-O Slats  
 GP-O Frame Kit = Profile Left + Profile Right + Rivets

	Price per ft <sup>2</sup>
P=0 mm/0''	\$13.00 /ft <sup>2</sup>
P=10 mm/0.39''	\$12.00 /ft <sup>2</sup>
<b>P=20 mm/0.79''</b>	<b>\$10.50 /ft<sup>2</sup></b>
P=30 mm/1.18''	\$10.00 /ft <sup>2</sup>
P=40 mm/1.57''	\$9.50/ft <sup>2</sup>

### Powder Coated Textured Colors (RAL)

**90031**

WHITE

**70301**

STONE GREY

**70121**

BASALT GREY

**70161**

ANTHRACITE GREY

**90051**

BLACK

**80191**

GREY BROWN

**80171**

CHOCOLATE BROWN



**All prices are subject to change without prior notice !!!**

## Horizontal Slat Gates /HDG/ (Hot Dip Galvanized!!!)



**Driveway Swing Gate /HDG/ GP-O**  
 1760x3660/20 5'10.08" x 12' /0.79"  
**\$2,000.00 /pc.**



**Pathway Gate /HDG/ GP-O**  
 1760x1220/20 5'10.08" x 4' /0.79"  
**\$990.00 /pc.**

For Gate  
13,1ft - 16ft W

### Standard Swing Gate Posts

Adjustable Ball Bearing Hinges

120x120/3mm, h-2,75m 4.72" x 4.72" /0.12" h 9'4.21"	120x120/3mm, h-2,75m 4.72" x 4.72" /0.12" h 9'4.21"	100x80/3mm, h-2,75m 3.94" x 3.15" /0.12" h 9'4.21"	100x80/3mm, h-2,75m 3.94" x 3.15" /0.12" h 9'4.21"	80x40/2mm, h-2,0m 3.15" x 1.57" /0.08" h 6'6.74"	80x40/2mm, h-2,0m 3.15" x 1.57" /0.08" h 6'6.74"
Post/HDG/ For Gates \$305.00 /pc	Post/HDG/ Additional \$260.00 /pc	Post/HDG/ For Gates \$209.00 /pc	Post/HDG/ Additional \$180.00 /pc	Post/HDG/ For Gates \$85.00 /pc	Post/HDG/ Additional \$70.00 /pc

\$362 /pc. (4mm) (16,1-18ft)

### Electromechanical Lock CISA



**\$250.00 /pc.**

### Standard Cantilever and Sliding Gate POSTS

80x80/3mm, h-2,8m 3.15" x 3.15" /0.12" h 9'4.21"	80x80/3mm, h-2,8m 3.15" x 3.15" /0.12" h 9'4.21"	80x80/3mm, h-2,8m 3.15" x 3.15" /0.12" h 9'4.21"
Post/HDG/ Support \$190 /pc.	Post/HDG/ STOP Cantilever \$190 /pc.	Post/HDG/ STOP Sliding \$190 /pc.

### Mechanical Lock CISA

**\$150.00 /pc.**

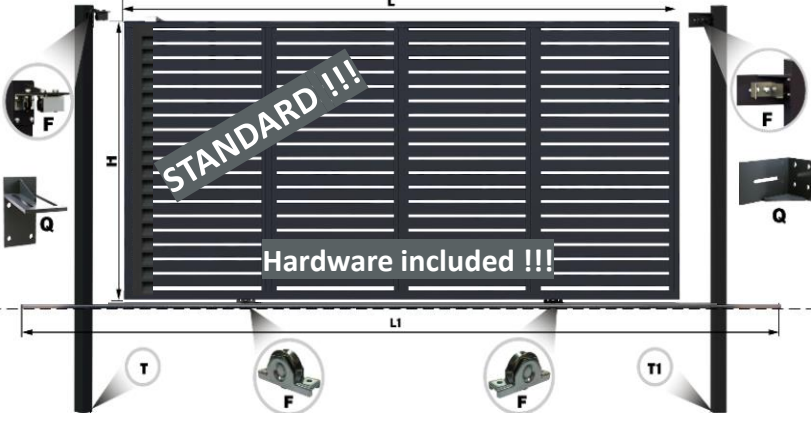

**Sliding Gate /HDG/ GP-O 1780x4600/20**  
 (5'10.47" x 15'1.1" /0.79") **\$2,585.00 / pc.**

**Hot Dip Galvanize Cantilever Gates**

**Cantilever Hardware**  
 400kg & 800kg +350 mm  
 Comunello +500 mm

**STOP/SUPPORT Frame for Concrete Column/Wall**  
 HDG - **\$30.00 /pc.**

### Custom Horizontal Slat Gates (price per sq ft)

**Incorporated Pathway Gates, add + 20% to the calculated price of the Gate**

GP-O/80	Driveway Swing Gate		Pathway Gate		Bi-Folding Gate	Sliding Gate	Cantilever Gate
	Hardware included		Lock NOT included !!!		Hardware NOT included !!!	Hardware included	Hardware included
	BB/HDG	For Gate 14.1 - 18ft !!! BB-XL/HDG	BB/ HDG	BB-XL/ HDG	HDG	HDG	HDG (Comunello Hardware +25%)
P=0 mm/0"	30.0	31.0	38.0	39.0	38.0	30.0	41.5
P=10 mm/0.39"	29.5	30.5	37.5	38.5	37.5	29.5	41.0
P=20 mm/0.79"	29.0	30.0	37.0	38.0	37.0	29.0	40.5
P=30 mm/1.18"	28.5	29.5	36.5	37.5	36.5	28.5	40.0
P=40 mm/1.57"	28.0	29.0	36.0	37.0	36.0	28.0	39.5

## Galvanized Horizontal Picket Fences XL-O (in the box / disassembled)

### STANDARD Horizontal Slat Panel

Picket BOX – 21 pc.

Frame BOX – 4 sets

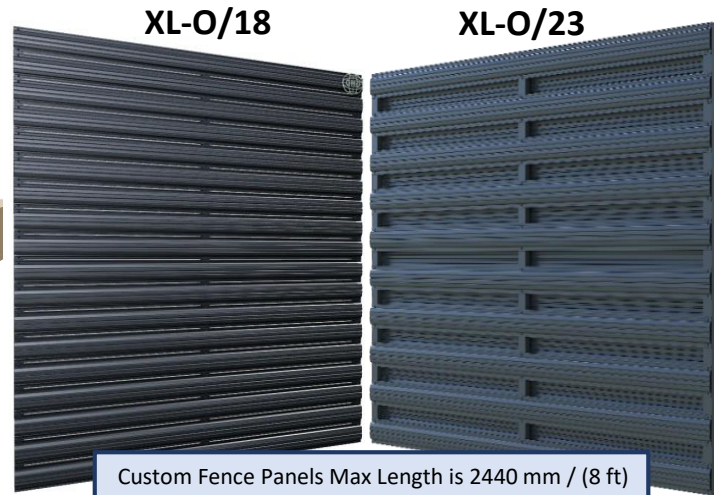

Custom Fence Panels Max Length is 2440 mm / (8 ft)

### Horizontal Fence Slats

Picket thickness - 0.7 mm

XL-O Picket - 100x1830 (3.94''x 6')

**\$6.50/pc.**

### Horizontal Picket Frame

Profile thickness - 0.9 mm

XL-O 1830x1830 (6'x 6')

**\$54.00 /kit**

### Horizontal Picket KIT

(GALVANIZED)

Electrostatic Powder Coating  
 cured at 392°F



Self-drilling screws 5,5 x 60



### Standard Horizontal Slat Panels XL-O (disassembled)

Panel Size	RAL / Stock	Slats	Pace	XL-O Frame	Rivets	Weight	Screws	Price\Kit
XL-O 1830X1830/23 double (6'x 6')	9005/9003	21 pc.	73mm 2.87"	h-1830 (6') / 1 kit	140 pc.	53lb/24 kg	8 pc.	<b>\$190</b>
XL-O 1830X1830/111 (6'x 6')	9005/9003	18 pc.	1 mm 0.04"	h-1830 (6') / 1 kit	125 pc.	46lb/21 kg	8 pc.	<b>\$171</b>

**Custom Size Horizontal Picket Fence Panel Kit: Starting at \$100.00 per panel**

CUSTOM Horizontal Slat Panels	Disassembled price \$/ft2	Kit Components
XL-O/23 (55-75 mm)	6.0	- XL-O slats/galvanized/predrilled - Pre-drilled pipe 40x27mm RAL - Profile U/XL-O - L shaped iron angle - Rivets - Self-drilling screws
XL-O/18 (7-14 mm)	5.0	
XL-O/16 (15-29 mm)	4.5	
XL-O/14 (30-54 mm)	4.0	
XL-O/11 (55-75 mm)	3.5	
XL-O/111 (1-6 mm)	5.5	

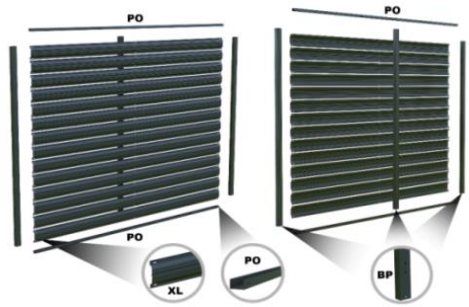

### Powder Coated Textured Colors (RAL)

90031

WHITE

70301

STONE GREY

70121

BASALT GREY

70161

ANTHRACITE GREY

90051

BLACK

80191

GREY BROWN

80171

CHOCOLATE BROWN



## Horizontal Double Picket Gates /HDG/ (Hot Dip Galvanized)



Driveway Swing Gate /HDG/XL-O  
 1760x4270/23 6'x 14' **\$1,700.00 set.**



Pathway Gate /HDG/XL-O  
 1760x1220/23 (6'x4')  
**\$765.00/pc.**

For Gate  
 13,1-16ft

### Standard Swing Gate Posts

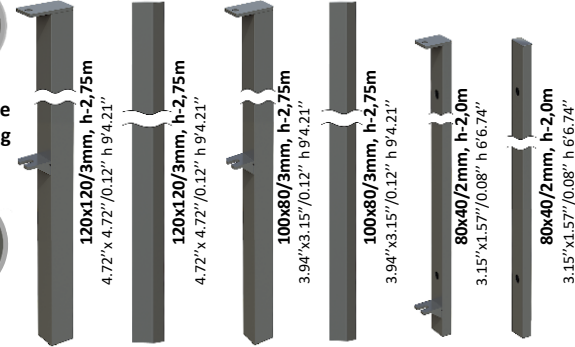

Post/HDG/ For Gates	Post/HDG/ Additional	Post/HDG/ For Gates	Post/HDG/ Additional	Post/HDG/ For Gates	Post/HDG/ Additional
120x120/3mm, h-2,75m 4.72"x 4.72"/0.12" h 9'4.21"	\$305.00 /pc	120x120/3mm, h-2,75m 4.72"x 4.72"/0.12" h 9'4.21"	\$260.00 /pc	100x80/3mm, h-2,75m 3.94"x 3.15"/0.12" h 9'4.21"	\$209.00 /pc
	<b>\$362.00 /pc.(4mm)</b>			100x80/3mm, h-2,75m 3.94"x 3.15"/0.12" h 9'4.21"	<b>\$180.00 /pc.</b>
	(16,1-18ft)			80x40/2mm, h-2,0m 3.15"x 1.57"/0.08" h 6'6.74"	<b>\$85.00 /pc.</b>
				80x40/2mm, h-2,0m 3.15"x 1.57"/0.08" h 6'6.74"	<b>\$70.00 /pc.</b>

### Electromechanical Lock CISA



**\$250.00 /pc.**

### Mechanical Lock CISA



**\$150.00 /pc**

### Standard Cantilever and Sliding Gate POSTS



80x80/3 h 2,8 3.15"x 3.15"/0.12" h 9'47.21"	80x80/3 h 2,8 3.15"x 3.15"/0.12" h 9'47.21"	80x80/3 h 2,8 3.15"x 3.15"/0.12" h 9'47.21"
Post/HDG/ Support	Post/HDG/ STOP Cantilever	Post/HDG/ STOP Sliding
<b>\$190.00 /pc.</b>	<b>\$190.00 /pc.</b>	<b>\$190.00 /pc.</b>



Sliding Gate /HDG/ XL-O 1780x4600/23  
 (6'x 15") **\$2,000.00/pc.**

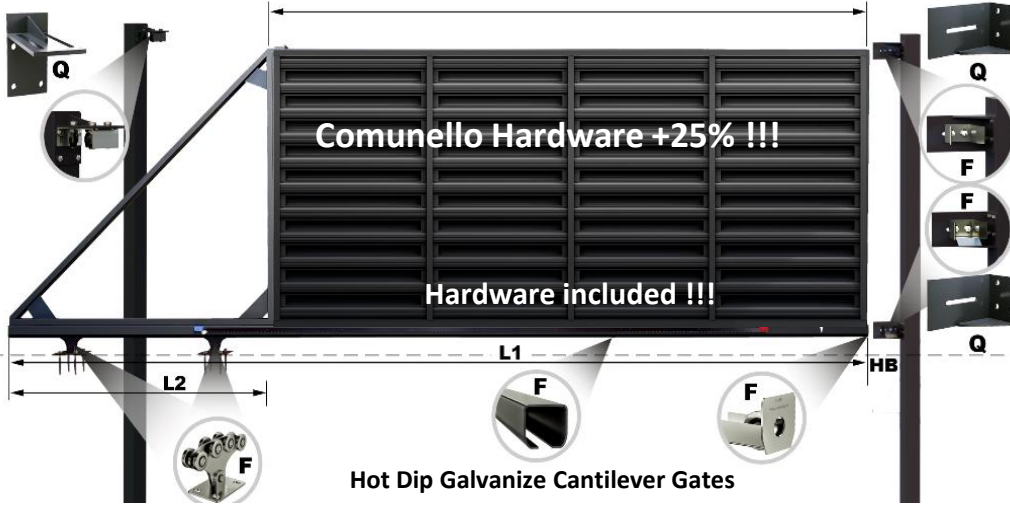

Hot Dip Galvanize Cantilever Gates



**Cantilever Hardware**  
 400kg & 800kg +350 mm  
 Comunello +500 mm

**STOP/SUPPORT Frame for Concrete Column/Wall HDG - \$30.00ea.**

## Custom Horizontal Picket Gates (price per sq ft) !!!

Incorporated Pathway Gates, add + 20% to the calculated price of the Gate

Horizontal Picket	Driveway Swing Gate		Pathway Gate		Bi-Folding Gate	Sliding Gate	Cantilever Gate
	Hardware included		Lock NOT included !!!		Hardware NOT included !!!	Hardware included	Hardware included
	BB/HDG	For Gate BB-XL/HDG 14,1-18ft !!!	BB/ HDG	BB-XL/ HDG	HDG	HDG	HDG (Comunello Hardware +25%)
XL-O/23+	20.5	21.5	27.0	28.0	30.0	22.5	33.5
XL-O/18	19.5	20.5	26.0	27.0	29.0	21.5	32.5
XL-O/16	19.0	20.0	25.5	26.5	28.5	21.0	32.0
XL-O/14	18.5	19.5	25.0	26.0	28.0	20.5	31.5
XL-O/11	18.0	19.0	24.5	25.5	27.5	20.0	31.0
XL-O/111	20.0	21.0	26.5	27.5	29.5	22.0	33.0

## Galvanized Picket Fence (disassembled)

### Picket Fence Kit Boxes

Picket BOX

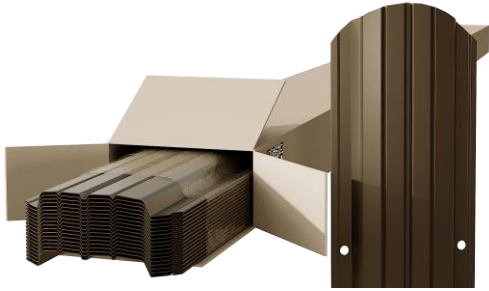

Frame BOX



Custom Fence Panels Max Length is 2440 mm / (8 ft)

### Picket Fence Slats

XL/Slat 100x1830mm (3.94''x 6') - **\$6.00/pc.**  
 XL/Slat 100x1220mm (3.94''x 4') - **\$4.25/pc.**

### Horizontal pipe

1830mm (6') - **\$9.00/pc.**

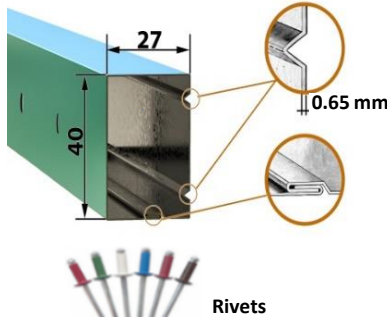
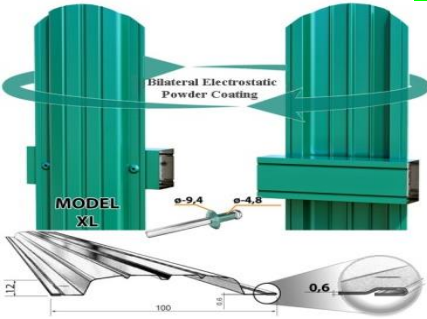

### Standard Picket Panels XL (disassembled)

Panel Size	RAL / Stock	Pickets	Pace	Predrilled horizontal pipe	Rivets	Weight	Price\Kit
XL 1830X1830/23 double (6'x 6')	9005	23 pc.	57mm 2.25"	L-1830 (6')/ 3 pc	155 pc.	51lb/23 kg	<b>\$165.00</b>
XL 1220X1830/23 double (4'x 6')	9005	23 pc.	57mm 2.25"	L-1830 (6')/ 2 pc	90 pc.	33lb/15 kg	<b>\$115.00</b>
XL 1830X1830/111 (6'x 6')	9005	18 pc.	1.5 mm 0.06"	L-1830 (6')/ 3 pc	125 pc.	40lb/18 kg	<b>\$135.00</b>
XL 1220X1830/111 (4'x 6')	9005	18 pc.	1.5 mm 0.06"	L-1830 (6')/ 2 pc	85 pc.	26lb/12 kg	<b>\$95.00</b>

CUSTOM Picket Panels XL	PRICE \$ /per sq ft	Kit Components
XL/23+ (55-75 mm)	5.00	- XL slats /galvanized /predrilled - Pre-drilled Pipe RAL - Rivets
XL/18 (7-14 mm)	4.00	
XL/16 (15-29 mm)	3.50	
XL/14 (30-54 mm)	3.00	
XL/11 (55-75 mm)	2.50	
XL/111 (1-6 mm)	4.50	

**CUSTOM Size Picket Fence Panel Kit: Starting at \$100.00 per panel**

### Picket Fence Holders



### Powder Coated Textured Colors (RAL)



**All prices are subject to change without prior notice !!!**

## Picket Gates /HDG/ (Hot Dip Galvanized!!!)



**Driveway Swing Gate /HDG/XL**  
 1760x4270/23 6'x 14' **\$1,400.00/set.**

Mechanical Lock Included !!!



**Pathway Gate /HDG/XL**  
 1760x1220/23 (6'x4') **\$660.00/pc.**

For Gate 13,1-16ftW

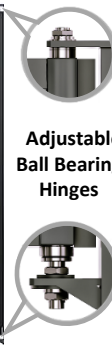

Adjustable Ball Bearing Hinges

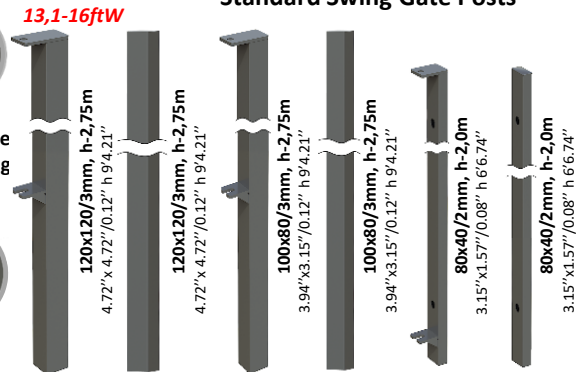

Standard Swing Gate Posts

Post/HDG/ For Gates	Post/HDG/ Additional	Post/HDG/ For Gates	Post/HDG/ Additional	Post/HDG/ For Gates	Post/HDG/ Additional
120x120/3mm, h-2,75m 4.72"x 4.72"/0.12" h 9'4.21"	\$305.00/pc	120x120/3mm, h-2,75m 4.72"x 4.72"/0.12" h 9'4.21"	\$260.00/pc	100x80/3mm, h-2,75m 3.94"x 3.15"/0.12" h 9'4.21"	\$209.00/pc
	\$362.00/pc. (4mm) (16,1-18ft)		\$260.00/pc		\$180.00/pc
			\$209.00/pc		\$85.00/pc
			\$209.00/pc		\$70.00/pc

**Electromechanical Lock CISA**



**\$250.00/pc.**

**Mechanical Lock CISA**



**\$150.00/pc.**

**Standard Cantilever and Sliding Gate POSTS**

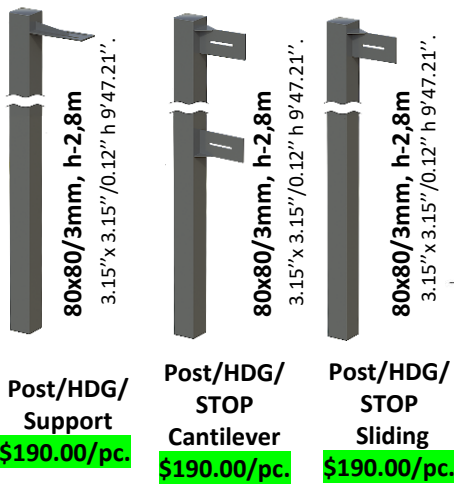

Post/HDG/ Support  
**\$190.00/pc.**

Post/HDG/ STOP Cantilever  
**\$190.00/pc.**

Post/HDG/ STOP Sliding  
**\$190.00/pc.**



**Sliding Gate /HDG/ XL 1780x4600/23**  
 (6'x 15'1.1") **\$1,800.00/pc.**

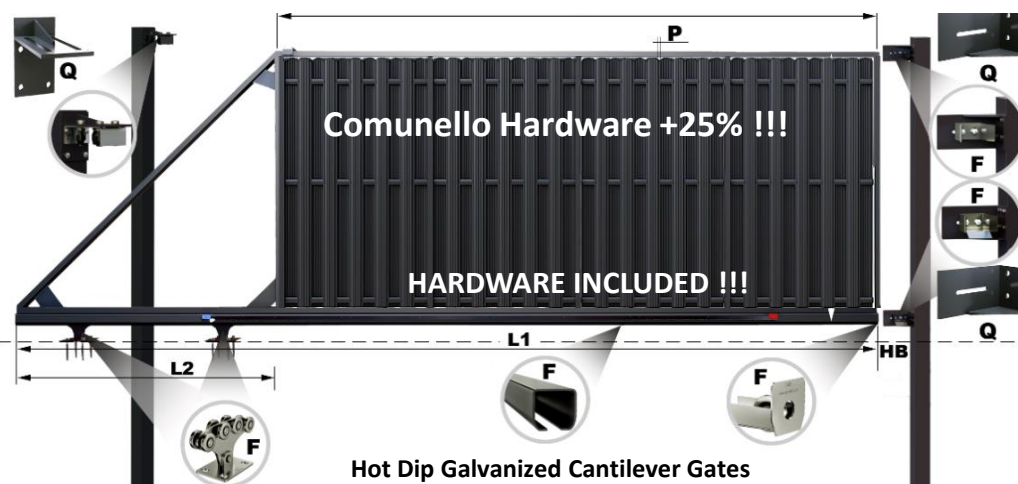

**Comunello Hardware +25% !!!**

**HARDWARE INCLUDED !!!**

**Hot Dip Galvanized Cantilever Gates**



**Cantilever Hardware**

400kg & 800kg +350 mm  
 Comunello +500 mm

**STOP/SUPPORT Frame for Concrete Column/Wall**  
 HDG - **\$30.00ea.**

**Custom Picket Gates (price per sq ft) !!!**

**Incorporated Pathway Gates, add + 20% to the calculated price of the Gate**

Picket	Driveway Swing Gate		Pathway Gate		Bi-Folding Gate	Sliding Gate	Cantilever Gate
	Hardware included		Lock NOT included !!!		Hardware NOT included !!!	Hardware included	Hardware included
	BB/HDG	For Gate BB-XL/HDG 14,1-18ft !!!	BB/ HDG	BB-XL/ HDG	HDG	HDG	HDG (Comunello Hardware +25%)
XL/23+	\$17.00	\$18.0	\$22.0	\$23.0	\$26.00	\$20.50	\$33.00
XL/18	16.00	17.00	21.00	22.00	25.00	19.50	32.00
XL/16	15.50	16.50	20.50	21.50	24.50	19.00	31.50
XL/14	15.00	16.00	20.00	21.00	24.00	18.50	31.00
XL/11	14.50	15.50	19.50	20.50	23.50	18.00	30.50
XL/111	16.50	17.50	21.50	22.50	25.50	20.00	32.50



## Fence and Gates Posts

### Hot Dip Galvanized Posts



**Antique Color + 15%**

h	40x40/2 (100x100/5)		50x50/2 (110x110/5)		60x60/2 (120x120/5)		60x60/3 (120x120/5)	
	ZnT	ZnT vopsit	ZnT	ZnT vopsit	ZnT	ZnT vopsit	ZnT	ZnT vopsit
1.0	20	22	24	27	29	36	40	44
1.2	24	26	29	32	35	42	48	52
1.4	28	31	35	39	42	50	57	62
1.5	29	33	36	40	43	52	59	64
1.8	36	41	45	50	54	65	74	81
2.0	38	43	47	53	57	69	78	85
2.2	50	55	61	67	73	88	102	109
2.4	51	57	63	70	76	91	105	114
2.6	53	59	65	73	79	95	109	118
2.8	55	61	67	76	81	98	112	122
3.0	57	64	70	78	84	102	116	127
h	60x40/2 (110x110/5)		60x40/3 (110x110/5)		80x40/2 (120x120/5)		80x40/3 (120x120/5)	
	ZnT	ZnT vopsit	ZnT	ZnT vopsit	ZnT	ZnT vopsit	ZnT	ZnT vopsit
1.0	28	31	39	41	32	36	46	49
1.2	33	36	45	49	38	42	54	58
1.4	38	42	54	58	45	49	64	69
1.5	40	44	56	60	46	51	66	71
1.8	49	54	69	74	57	63	83	89
2.0	54	60	77	83	63	70	92	99
2.2	65	72	93	100	76	84	111	119
2.4	68	75	97	104	79	87	115	124
2.6	70	77	100	107	81	90	119	128
2.8	72	80	103	111	84	94	123	133
3.0	74	83	106	115	87	97	127	138
h	80x80/2 (150x150/5)		80x80/3 (150x150/5)		100x100/3 (180x180/6)		100x100/4 (180x180/6)	
	ZnT	ZnT vopsit	ZnT	ZnT vopsit	ZnT	ZnT vopsit	ZnT	ZnT vopsit
2.0	76	85	112	121	140	151	185	197
2.2	99	109	145	155	181	194	241	253
2.4	102	113	150	161	188	202	249	263
2.6	106	118	155	167	194	210	258	273
2.8	109	122	161	174	201	217	267	283
3.0	113	127	166	180	207	225	275	293

### Hot Dip Galvanized Posts for Gates

#### Hot Dip Galvanized H-Frame for Pathway Gate 4'W

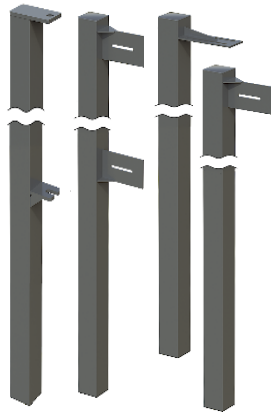

80x80/3mm - \$500.00/pc.  
 100x80/3mm - \$550.00/pc.

h	for Gate /80x80/3 - BA		for Gate /100x80/3 - BA		for Gate /100x100/3 - BA		for Gate /100x100/4 - BA-xl	
	ZnT	ZnT vopsit	ZnT	ZnT vopsit	ZnT	ZnT vopsit	ZnT	ZnT vopsit
2.0	130	139	144	154	163	174	206	218
2.2	162	172	178	189	203	215	260	273
2.4	167	178	183	196	209	223	269	282
2.6	172	184	189	202	216	230	277	292
2.8	177	190	195	209	222	238	286	301
3.0	182	196	200	215	228	245	294	311
h	for Gate /120x120/4 - BA-xl		for Gate /140x140/4 - BA-xl		for Gate /140x140/5 - BA-xl		for Gate /160x160/5 - BA-xl	
	ZnT	ZnT vopsit	ZnT	ZnT vopsit	ZnT	ZnT vopsit	ZnT	ZnT vopsit
2.0	248	262	290	306	352	367	400	418
2.2	313	328	365	383	446	463	510	530
2.4	323	339	377	396	461	480	527	549
2.6	333	351	389	409	476	496	544	568
2.8	343	362	401	423	490	512	561	586
3.0	353	374	413	436	505	529	578	605
h	for Gate /80x40/2 - BA		for Gate /80x40/3 - BA-xl		for Gate /80x40/4 - BA-xl		for Gate /160x80/5 - BA-xl	
	ZnT	ZnT vopsit	ZnT	ZnT vopsit	ZnT	ZnT vopsit	ZnT	ZnT vopsit
2.0	78	85	106	113	134	142	215	229
2.2	90	97	124	132	160	167	253	267
2.4	93	101	128	136	165	173	260	276
2.6	95	104	132	141	170	179	268	285
2.8	98	107	136	145	175	185	276	294
3.0	100	110	139	150	180	190	283	303

### Welded Base Plates

**Antique Color + 15%**

Talpa p/u Stilpi								
	ZnT	ZnT vopsit		ZnT	ZnT vopsit		ZnT	ZnT vopsit
100/5	11	13	120/5	16	18	180/6	34	40
110/5	13	15	150/5	22	26	200/6	42	48

### Galvanized Posts for Fence Panels

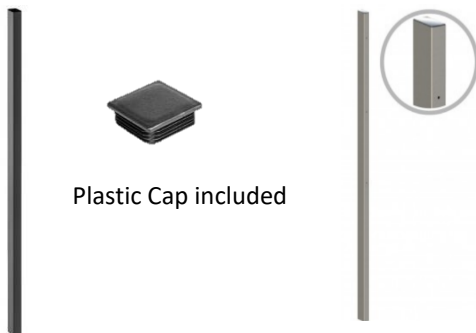

Plastic Cap included

h	60x40/1.5		60x40/2		60x60/2	
	Zinc	Zinc vopsit	Zinc	Zinc vopsit	Zinc	Zinc vopsit
1.0	15	17	19	22	22	26
1.2	17	20	22	25	26	30
1.4	20	23	26	30	31	36
1.5	20	24	26	30	31	36
1.8	26	31	34	39	41	47
2.0	25	30	33	38	39	46
2.2	31	37	41	47	49	56
2.4	31	37	41	47	49	57
2.6	37	44	49	56	58	67
2.8	37	44	49	56	58	67
3.0	37	44	49	56	58	68

## Hardware for Cantilever Gates

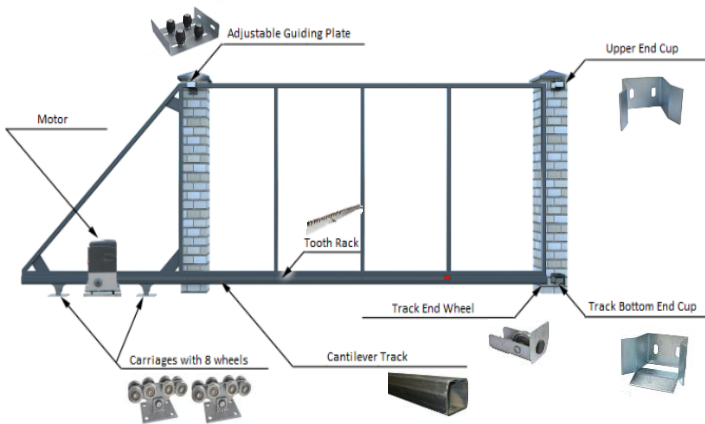

**800 kg (1764 lbs)/HDG/**

### Cantilever Hardware

- Cantilever Carriage with 8 wheels-2 pc.
- Adjustable Guiding Plate -1pc.
- Cantilever Track Bottom End Cup - 1pc.
- Cantilever Track End Wheel -1 pc.
- Upper End Cup - 1pc.

**Cantilever Track /HDG/  
6m (9'8")**

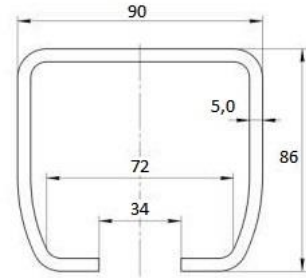

**Cantilever Track /HDG/  
Parameters in mm (millimeters)**

## Automation System for Swing Gates



Mastiff 400 (Wi-Fi) (Max Gate Length 3800 mm (12' 5.6"))	<ul style="list-style-type: none"> <li>• Motor 2 pc.</li> <li>• Kit Wi-Fi -1 pc,</li> <li>• photo elements 2 pc ,</li> <li>• remote 2 pc</li> <li>• light signal 1 pc</li> </ul>	<b>\$820.00</b>
Mastiff 400L (Wi-Fi) (Max Gate Length 4500 mm (14' 9.2"))		<b>\$915.00</b>

## Automation System for Cantilever/Sliding Gates



<b>Husky-1200</b>	<ul style="list-style-type: none"> <li>• Motor 2 pc.</li> <li>• Kit Wi-Fi -1 pc</li> <li>• photo elements 2 pc</li> <li>• remote 2 pc</li> <li>• light signal 1 pc</li> </ul>	<b>\$530.00</b>
<b>2 year GUARANTEE</b>		

## Gate Accessories

	Tooth Rack Galvanized	<b>\$ 20.00</b>		Rivets	<b>\$ 0.15</b>
				Latch	<b>\$ 11.00</b>
	Adjustable Ball Bearing Hinge (TOP)	<b>\$ 25.00</b>		Gate Cane Bolt	<b>\$ 42.00</b>
	Adjustable Ball Bearing Hinge (BOTTOM)	<b>\$ 40.00</b>		Frame for Automation with Outward Opening HDG	<b>\$ 30.00</b>

## Galvanized Louvered Fence GJ/60 (in the box / disassembled)

### STANDARD 6'x6' Louvered Fence Panel KIT

Louvered Slats BOX – 22 pc.

Frame BOX – 1 sets

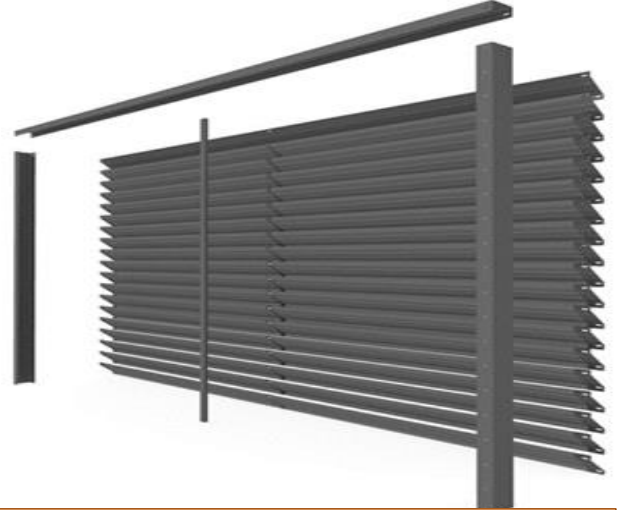

Custom Fence Panels Max Length is 2440 mm / (8 ft)

### Louvered Panel SLATS

Slats thickness - 0.85 mm  
 LS 110x1816mm - **\$9.5ea.**  
 (4.33''x 5'11.5'')

### Louvered FRAME kit

Profile thickness - 1.2 mm  
 1769x1830/90mm - **\$57.00ea.**  
 (5'9.65'' x6'/0.3')

### Louvered Fence KIT

electrostatic Powder Coating  
 cured at 392°F

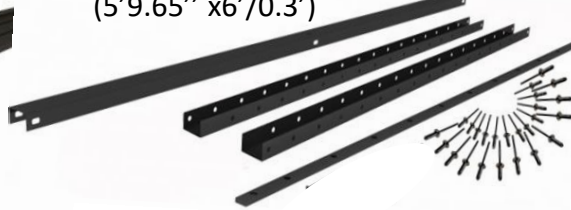

### **STANDARD Louvered Panel Kits (disassembled)**

Panel Size	RAL/STOCK	SLATS	GJ FRAME	Rivets	Weight	Pace	PRICE /KIT
GJ 1769x1830/80 (5'9.65" X 6')	9005	22 pc.	1 kit	125 pc.	73 lb/33kg	80 mm (3.14'')	<b>\$266.00</b>

### **CUSTOM**

Louvered Panel Kits (in the box/disassembled)

GJ KIT= GJ Frame + GJ Slats

GJ Frame Kit = Profile Left + Profile Right + Reinforcement profile + Rivets

Pace	Price /sq ft
<b>80 mm (3.14'')</b>	<b>\$8.00</b>
100 mm (3.94'')	\$7.50
120 mm (4.72'')	\$7.00

**Custom Size Louvered Fence Panel Kit: Starting at \$150.00 per panel.**

### **Powder Coated Textured Colors (RAL)**

**90031**

WHITE

**70301**

STONE GREY

**70121**

BASALT GREY

**70161**

ANTHRACITE GREY

**90051**

BLACK

**80191**

GREY BROWN

**80171**

CHOCOLATE BROWN



**All prices are subject to change without prior notice !!!**

## Louvered Gates GJ/60/HDG/ (Hot Dip Galvanized)



**Driveway Swing Gate /HDG/GJ**  
 1769x4270/80 mm - 5.8'x14'/0.26'  
**\$1,900.00 /pc.**



**Pathway Gate /HDG/GJ**  
 1769x1220/80mm  
 (5.8'x 4' / 0.26') **\$825.00 /pc.**

**For Gate 13,1-16ftW**

**STANDARD SWING GATE POSTS**

120x120/3mm, h-2,75m 4.72'x 4.72' / 0.12" h 9'4.21"	120x120/3mm, h-2,75m 4.72'x 4.72' / 0.12" h 9'4.21"	100x80/3mm, h-2,75m 3.94'x3.15' / 0.12" h 9'4.21"	100x80/3mm, h-2,75m 3.94'x3.15' / 0.12" h 9'4.21"	80x40/2mm, h-2,0m 3.15'x1.57' / 0.08" h 6'6.74"	80x40/2mm, h-2,0m 3.15'x1.57' / 0.08" h 6'6.74"
Post/HDG/ For Gates <b>\$305.00 /pc</b> <b>\$362.00 /pc.</b> (4mm) (16,1-18ft)	Post/HDG/ Additional <b>\$260.00 /pc</b>	Post/HDG/ For Gates <b>\$209.00 /pc</b>	Post/HDG/ Additional <b>\$180.00 /pc</b>	Post/HDG/ For Gates <b>\$85.00 /pc</b>	Post/HDG/ Additional <b>\$70.00 /pc</b>

**Electromechanical Lock CISA**



**\$250.00 /pc.**

**Mechanical Lock CISA**



**\$150.00 /pc**

**Standard Cantilever and Sliding Gate POSTS**

80x80/3mm, h-2,8m 3.15'x 3.15' / 0.12" h 9'47.21"	80x80/3mm, h-2,8m 3.15'x 3.15' / 0.12" h 9'47.21"	80x80/3mm, h-2,8m 3.15'x 3.15' / 0.12" h 9'47.21"
Post/HDG/ Support <b>\$190.00 /pc.</b>	Post/HDG/ STOP Cantilever <b>\$190.00 /pc.</b>	Post/HDG/ STOP Sliding <b>\$190.00 /pc.</b>



**Sliding Gate /HDG/ GJ 1790x4600/80**  
 (5.9'x 15' / 0.3') **\$2,145.00/pc.**

**Hot Dip Galvanized Cantilever Gates**

**Cantilever Hardware**

400kg & 800kg +350 mm  
 Comunello +500 mm

**STOP/SUPPORT Frame for Concrete Column/Wall**  
 HDG - **\$30.00ea.**

**Custom Louvered Gates GJ/60 (price per sq ft) !!!**

**Incorporated Pathway Gates, add + 20% to the calculated price of the Gate**

Louvered Fence	Driveway Swing Gate		Pathway Gate		Bi-Folding Gate	Sliding Gate HDG	Cantilever Gate HDG
	Hardware included		Lock NOT included !!!		Hardware NOT included !!!	Hardware included	Hardware included
	BB/HDG	For Gate BB-xl/HDG 14,1 - 18ft !!!	BB/HDG	BB-xl/HDG	HDG	HDG	HDG (Comunello Hardware +25%)
80 mm (0.26')	23.5	24.5	29.0	30.0	30.5	25.0	36.5
100 mm (0.33')	23.0	24.0	28.5	29.5	30.0	24.5	36.0
120 mm (0.4')	22.5	23.5	28.0	29.0	29.5	24.0	35.5